

# Gladius G1052C

## 10.4" Intel® Celeron® N2930 Rugged Tablet PC



### Features

- 10.4" AFFS+ TFT Active Matrix with Capacitive Touch Panel
- Ultra low power consumption
- Fully rugged for mobile POS or warehousing application
- Meeting MIL-STD-810G, IP54, 4 ft. drop resistance
- High mobility, multiple connectivity (Bluetooth/WLAN/WWAN)
- Identification devices (barcode scanner, RFID & NFC reader and MSR)
- Hot-swappable external battery w/ redundant internal battery
- 23-key keypad with numeric keys and function Keys
- I.P.A. (Isopropyl) alcohol clearing allowed

### System

CPU	Intel® Celeron® Processor N2930 quad-core 1.83 GHz
Graphics Controller	Intel® HD Graphics
Memory	2GB DDR3L SO-DIMM memory module installed (optional up to 8GB)
BIOS	UEFI BIOS
Audio	1 x microphone 1 x 2W speaker 1 x Earphone jack
Storage	1 x 32GB MLC mSATA SSD

### Peripherals and Devices

Camera	1 x 5.0 MP rear AF CMOS camera with LED
WLAN & Bluetooth	1 x WLAN 802.11 a/b/g/n & Bluetooth 4.0 LE, class 2
RFID & NFC	1 x 13.56MHz, ISO 15693/14443A/ 14443B RFID & NFC Reader (distance: 3~5cm; speed: 5 cards/sec) (optional)
WWAN	HSUPA / HSPA+ / LTE (optional)
Barcode Scanner	1 x 1D/2D Barcode scanner (optional)
MSR	1x Magnetic Stripe Reader (optional)
Smart Card Reader	1x Smart Card Reader (optional)
GPS	U-BLOX 6 GPS Receiver (optional)

### I/O Interface

USB Port	1 x USB 3.0 Type-A port
SD Card	1 x SD/SDHC/SDXC slot
Docking Port	1 x 35-pin pogo connector for docking connection
Expansion	1 x USB 2.0 Type-A or USB Sensor Hub

### Button & Indicator

Function Key	10 x Numeric keys (0 ~ 9); 1 x Enter key; 1 x 4-way navigation key; 4 x Function keys;	1 x Ctrl key; 1 x Backspace; 1 x Dot (.) key; 1 x Brightness key;
Power Button	1 x Power on/off button	
LED Indicator	1 x Battery LED 1 x WLAN/RFID LED 1 x Bluetooth/WWAN LED	

### Touch Screen

Type	10-Point Projected Capacitive Touch with Corning® Gorilla Glass
Light Transparency	80% (typ.)
Controller Interface	USB Interface

### LCD Display

Size/Type	10.4" XGA TFT color LCD with LED backlight
Max. Resolution	1024 x 768 (XGA) w/ 262,144 colors
Luminance	340 cd/m <sup>2</sup> (typ.)
Contrast Ratio	600 :1
View Angle (U/D/R/L)	89°/89°/89°/89°
Backlight Type	LED

### Power Supply

Adapter Input	100 ~ 240VAC (full range)
Adapter Output	19VDC, 3.42A, 65W
Battery Type	Li-battery pack 1 x 2500mAh 4-cell external battery pack 1 x 1880mAh 3-cell internal battery pack (optional)
Battery Capacity	Up to 8 hours (depends on configuration and use)

### Mechanical & Environmental

Operating Temp.	-20 ~ 45°C (-4 ~ 113°F)
Storage Temp.	-20 ~ 60°C (-4 ~ 140°F)
Discharging Temp.	-20 ~ 45°C (-4 ~ 113°F)
Charging Temp.	0 ~ 40°C (32 ~ 104°F)
Operating Humidity	10 ~ 95% @ 45°C (non-condensing)
Dimensions (W x H x D)	205 x 294 x 25 mm (8.07" x 11.57" x 0.98")
Gross Weight	1.2 kg (2.64 lb) w/o 2-cell internal battery pack 20 to 1000 Hz @ 1 grms per MIL-STD 810G (operating) 20 to 1000 Hz @ 3 grms per MIL-STD 810G (non-operating) 11 ms @ 20G per MIL-STD 810G for unit only (operating)
Vibration	11 ms @ 40G per MIL-STD 810G for unit only (non-operating)
Shock	1.2m (4ft.) per MIL-STD-810G for whole unit
Transit Drop	IP54
IP Rating	CE: EN55022 class B FCC 47 CFR, Part 15 Subpart B
Regulatory	

### OS Support

Windows Embedded 7 / Windows 7 Professional
Windows Embedded Standard 8.0 / Windows Embedded 8.1 Industry Pro / Windows 8.1 Professional

### Ordering Information

G1052C	10.4" Intel® Celeron® N2930 rugged tablet PC with projected capacitive touch, battery pack, WLAN and Bluetooth
	10.4" Intel® Celeron® N2930 rugged tablet PC with projected capacitive touch, battery pack, WLAN and Bluetooth, and sunlight readable display (800 nits)

按此連結 [Click Here](#)  
 天時科技有限公司  
**ACTION-PLUS CO., LTD**  
 Tel : (852) 2803 0306  
 Fax : (852) 2887 2892  
 Email : sales@action-plus.com.hk  
 Website: www.action-plus.com.hk





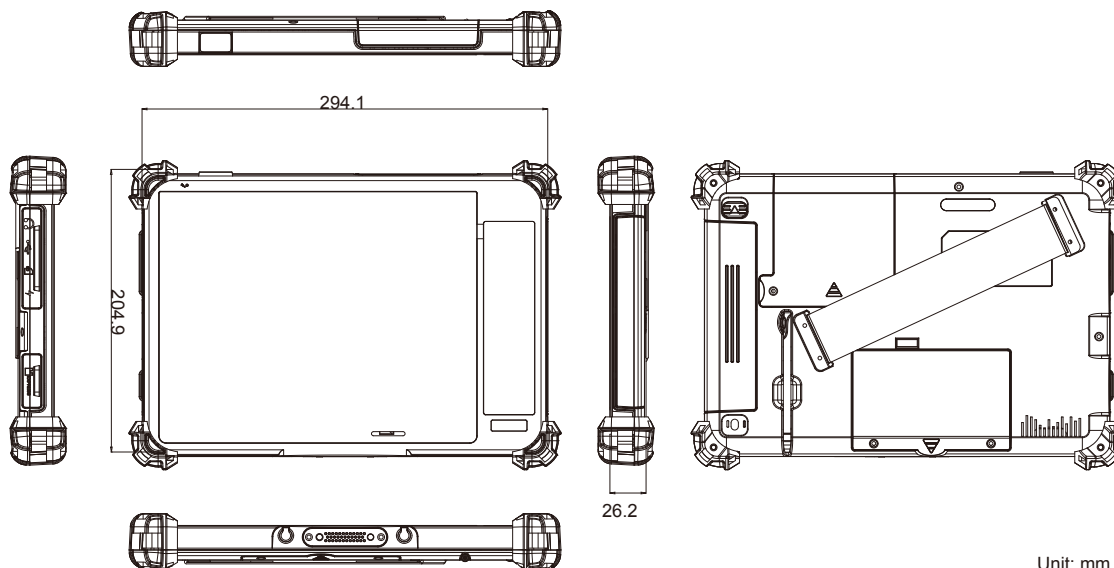

## Dimensions











Unit: mm









### Standard Accessories

Power Adapter	19V/3.42A 65W AC/DC adapter kit	
Hand Strap	212mm black elastic hand strap	
eBAT-1050	2500mAh 4-cell external battery pack for G105X	
Touch Pen	Capacitive touch pen	

### Optional Accessories

Power Adapter	19V/3.42A 65W AC/DC adapter kit	
SST-0720	Shoulder strap, 128 x 3.7cm	
eBAT-1050	2500mAh 4-cell external battery pack for G105X	
iBAT-1040	1880mAh 3-cell internal battery pack for G105X	
NST-1050	Neck Strap, 120 x 4 x 0.6 cm for G105X	
VSB-100	VESA-75 to VESA-100 adapter bracket	
VMB-1050	VESA mount bracket for G105X	
DTC-1050	Desktop cradle for G105X	
CHR-1050	Dual-bay external battery charger for G105X	

### Optional Configuration (CTOS\* Kit) (Not Sold Separately)

UDG-1050	USB dongle kit	
BarC-1052	1D/2D barcode scanner kit	
HSUPA-1052	3.75G HSUPA wireless kit	
GRS-1050	GPS and RS-232 2-in-1 kit	
SRS-1050	Smart Card Reader and RS-232 2-in-1 kit	
MSR-1050	MSR module kit	
RFID & NFC-1050	13.56MHz RFID & NFC kit	
CAM-1052	5.0M rear CMOS camera kit	
LTE-1052	4G LTE Wi	

Note: The GRS, SRS and MSR cannot co-exist

[按此連結 Click Here](#)  
 天時科技有限公司  
**ACTION-PLUS CO., LTD**  
 Tel : (852) 2803 0306  
 Fax : (852) 2887 2892  
 Email : sales@action-plus.com.hk  
 Website: www.action-plus.com.hk

\*CTOS means Configure-to-Order Service.  
 position. Please select any one of them.  
 subject to change without notice. Last update: 20/5/2015