

## Lemur-2 Specifications



### General

**Print Method:** direct thermal  
**Print Speed:** 10" per sec. maximum  
**Resolution:** 203 (8 dots/mm), 300 dpi (12 dots/mm) or 600 dpi (optional)  
**Size:** 19,6H x 32,8W x 21,0L cm (7.7H x 12.9W x 8.25L inches)  
**Weight:** 6,3 kg (14 lbs.)

### Media Transport

**Media Type:** fanfolded tickets  
**Ticket Thickness:** .004" to .011"  
**Receipt Thickness:** .002" to .008"  
**Ticket Width:** 2.0" to 3.25"  
**Premium options:** 1.0" to 2.0" or 2.0" to 4.0"  
**Receipt Width:** 3.125" (80 mm)  
**Positioning:** optical detector senses black mark (ticket) or paper (receipt)  
**Ticket Separation:** manual tear-off or optional cutter with hopper (horizontal) or top plate (vertical)

### Interfaces

**Standard:** Serial, Parallel and USB  
**Optional:** Ethernet, Bluetooth & Wi-Fi

### Protocols

**Standard:** FGL  
**Drivers:** Windows, Mac and Linux

### Approvals

Designed to meet: UL / FCC / CE / CCC / ENERGY STAR / RoHS

### RFID (optional)

ISO14443, ISO15693, UHF EPC Gen2, Others available upon request

### Power Requirements

100-240 VAC, 50/60 Hz, 80W max  
 24 VDC, 100W max

### Power Consumption

**Standby:** 5W  
**Normal printing:** 34W

### Environmental

**Operating Temperature:** -20° to 60°C\*  
**Relative Humidity:** 10% to 90%  
**Storage Temperature:** -40 to 70°C above specs without condensation

### Bar Codes

Most 1D and 2D codes including PDF417, DataMatrix, QR, Aztec

Full speed printing of picket fence and ladder bar codes

### Fonts

**Resident fonts:** 16 bitmapped fonts (including Cyrillic and German characters) and Asian character sets (optional)

**Downloadable fonts:** HP Soft fonts / TrueType fonts

**Downloadable RAM:** up to 27MB  
**Downloadable Flash:** up to 28MB (optional)

### Graphics

FGL format, PCX format (1bit b/w), BMP format (1bit b/w)

### Web Interface - Ethernet only

Real-time status monitor  
 Email notification

### Projected Life

**Cutter:** 1 million cuts  
**Print Head:** 150 km of paper or 100 million dot activations

### Warranty

**Printer:** 1 year, parts and labor  
**Print head:** 90 days

**Life time print head warranty when using exclusively our tickets.**

### Patents

BOCA has a patented head protection system that prevents premature head failure

Show with Vertical Option

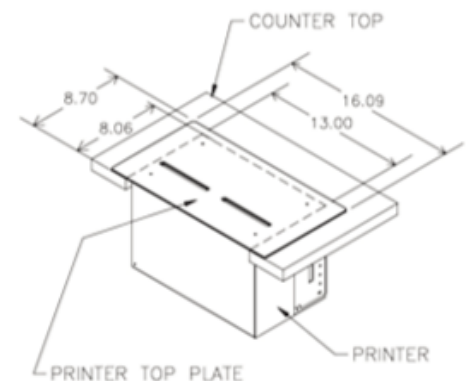

\* Print speed may be affected at extreme temperatures